

为您的产品保驾护航

PRODUCT DATASHEET

Surface Mount PTC Devices

**ASMD0603SL Series Surface Mount PTC Devices**



### Description

The ASMD0603SL series provides miniature surface mount resettable overcurrent protection with holding current from 0.35mA to 3.0A.



This world's smallest PTC is suitable for ultra portable applications where space is at a premium and the device current is low.

### Features

- Ultra low resistance
- RoHS compliant and lead-free
- Halogen-free
- Fast response to fault current
- Symmetrical design

### Agency Approvals

Agency	File Number
	Pending

Regulation	Standard
	2002/95/EC
	EN14582

### Applications

- USB port protection - USB 2.0, 3.0&OTG
- Li-ion/Li-Polymer battery packs
- PDAs / digital cameras
- Computer peripherals
- PC motherboards-plug and play protection

**Electrical Characteristics**

Model	I <sub>hold</sub> @25°C (A)	I <sub>trip</sub> @25°C (A)	V <sub>max</sub> (V)	I <sub>max</sub> (A)	P <sub>d</sub> Typ. (W)	Maximum Time To Trip		Resistance	
						Current (A)	Time (Sec)	R <sub>i min</sub> (Ω)	R <sub>1max</sub> (Ω)
ASMD0603SL035	0.35	0.7	6	50	0.5	8.0	0.1	0.150	1.000
ASMD0603SL035-12V	0.35	0.7	12	50	0.5	8.0	0.1	0.150	1.000
ASMD0603SL050	0.50	1.0	6	50	0.5	8.0	0.6	0.070	0.400
ASMD0603SL050-12V	0.50	1.0	12	50	0.5	8.0	0.6	0.070	0.400
ASMD0603SL075	0.75	1.5	6	50	0.5	8.0	1.0	0.055	0.250
ASMD0603SL075-12V	0.75	1.5	12	50	0.5	8.0	1.0	0.055	0.250
ASMD0603SL100	1.00	2.0	6	50	0.5	8.0	2.0	0.045	0.120
ASMD0603SL100-12V	1.00	2.0	12	50	0.5	8.0	2.0	0.045	0.120
ASMD0603SL125	1.25	2.5	6	50	0.5	8.0	3.0	0.035	0.100
ASMD0603SL125-12V	1.25	2.5	12	50	0.5	8.0	3.0	0.035	0.100
ASMD0603SL150	1.50	3.0	6	50	0.5	8.0	4.0	0.025	0.080
ASMD0603SL150-12V	1.50	3.0	12	50	0.5	8.0	4.0	0.025	0.080
ASMD0603SL175	1.75	3.5	6	50	0.5	8.0	5.0	0.015	0.070
ASMD0603SL175-12V	1.75	3.5	12	50	0.5	8.0	5.0	0.015	0.070
ASMD0603SL200	2.00	4.0	6	50	0.5	8.0	5.0	0.012	0.060
ASMD0603SL200-12V	2.00	4.0	12	50	0.5	8.0	5.0	0.012	0.060
ASMD0603SL250	2.50	5.0	6	50	0.5	8.0	5.0	0.010	0.055
ASMD0603SL250 -12V	2.50	5.0	12	50	0.5	8.0	5.0	0.010	0.055
ASMD0603SL260	2.60	5.2	6	50	0.5	8.0	5.0	0.008	0.050
ASMD0603SL260-12V	2.60	5.2	12	50	0.5	8.0	5.0	0.008	0.050
ASMD0603SL300	3.00	6.0	6	50	0.5	8.0	5.0	0.008	0.040
ASMD0603SL300-12V	3.00	6.0	12	50	0.5	8.0	5.0	0.008	0.040

I<sub>hold</sub> = Hold Current. Maximum current device will not trip in 25°C still air.

I<sub>trip</sub> = Trip Current. Minimum current at which the device will always trip in 25°C still air.

V<sub>max</sub> = Maximum operating voltage device can withstand without damage at rated current (I<sub>max</sub>).

I<sub>max</sub> = Maximum fault current device can withstand without damage at rated voltage (V<sub>max</sub>).

P<sub>d</sub> = Power dissipation when device is in the tripped state in 25°C still air environment at rated voltage.

R<sub>i min/max</sub> = Minimum/Maximum device resistance prior to tripping at 25°C.

R<sub>1max</sub> = Maximum device resistance is measured one hour post reflow.

CAUTION : Operation beyond the specified ratings may result in damage and possible arcing and flame.

### Test Procedures and Requirements

Test	Conditions	Accept/Reject Criteria
Ri min	Resistance measurement at 25°C	$R_{i\min} \leq R \leq R_{1\max}$
R1 max	Resistance measurement one hour after post trip	$R_{i\min} \leq R \leq R_{1\max}$
I-hold	Hold rated current 1800s without trip, @ 25°C	No trip
I-trip	Device must trip within 900s under rated current, @25°C	Trip
Max. time to trip	At specified current, 25°C	$T \leq \text{max. Time to Trip(s)}$
Trip Cycle Life	Vmax, Imax, 100 cycles	No arcing or burning
Trip Endurance	Vmax, Imax 24 hours	No arcing or burning
Solderability	ANSI/J-STD-002	95% min. coverage

### Environmental Specifications

Conditions	Resistance change
Operating Temperature	-40 °C to +85 °C
Max. Device Surface Temperature in Tripped State	125°C
Passive Aging	+85 °C, 1000 h ; ±10 % typical resistance change
Humidity Aging	+85 °C, 85 % R.H. 100 h; ±15 % typical resistance change
Thermal Shock	MIL-STD-202, Method 107; +85 °C to -40 °C, 20 times;-30 % typical resistance change
Solvent Resistance	MIL-STD-202, Method 215 ; No change
Vibration	MIL-STD-883, Method 2007, Condition A; No change
Moisture Sensivity Level	Level 2, J-STD-020
Storage Conditions	+30 °C Max. 60% RH Max. Packed in original packaging.

**Thermal Derating Chart**

Model	Maximum ambient operating temperature ( $T_{mao}$ ) vs. hold current ( $I_{hold}$ )								
	- 40°C	- 20°C	0°C	25°C	40°C	50°C	60°C	70°C	85°C
ASMD0603SL035	0.46	0.40	0.37	0.35	0.29	0.25	0.24	0.20	0.14
ASMD0603SL050	0.73	0.66	0.57	0.50	0.44	0.38	0.35	0.30	0.24
ASMD0603SL075	1.10	0.99	0.86	0.75	0.66	0.58	0.52	0.45	0.36
ASMD0603SL100	1.46	1.32	1.14	1.00	0.87	0.77	0.70	0.61	0.48
ASMD0603SL125	1.83	1.65	1.43	1.25	1.09	0.96	0.87	0.76	0.60
ASMD0603SL150	2.19	1.98	1.72	1.50	1.31	1.15	1.05	0.91	0.71
ASMD0603SL175	2.56	2.31	2.00	1.75	1.53	1.34	1.22	1.06	0.83
ASMD0603SL200	2.92	2.64	2.29	2.00	1.75	1.54	1.39	1.21	0.95
ASMD0603SL250	3.65	3.30	2.86	2.50	2.18	1.92	1.74	1.51	1.19
ASMD0603SL260	3.80	3.43	2.98	2.60	2.27	2.00	1.81	1.57	1.24
ASMD0603SL300	4.38	3.96	3.43	3.00	2.62	2.31	2.09	1.82	1.43

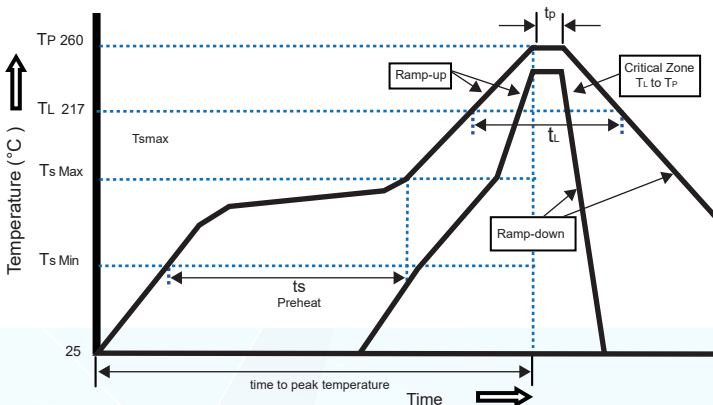
**Soldering Parameters**

Profile Feature	Pb-Free Assembly
Average Ramp-Up Rate( $T_{sMax}$ to $T_p$ )	3°C/s Max.
-Temperature Min( $T_{sMin}$ )	150°C
Preheat -Temperature Max( $T_{sMax}$ )	200°C
-Time( $t_{sMin}$ to $t_{sMax}$ )	60~180 s
Time maintained -Temperature( $T_L$ )	217°C
above: -Time( $t_L$ )	60~150 s
Peak/Classification Temperature( $T_p$ )	260 $_{+0/-5}$ °C
Time within 5°C of actual peak temperature( $t_p$ )	20~40 s
Ramp down rate	6°C/s Max.
Time 25°C to peak temperature	8 min. Max.

- ◆ All temperature refer to topside of the package, measured on the package body surface
- ◆ If reflow temperature exceeds the recommended profile, devices may not meet the performance requirements
- ◆ Recommended reflow methods: IR, vapor phase oven, hot air oven, N2 environment for lead
- ◆ Recommended maximum paste thickness is 0.25mm (0.010inch)
- ◆ Devices can be cleaned using standard industry methods and solvents

Physical Dimensions(mm.)

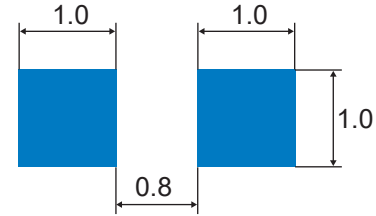
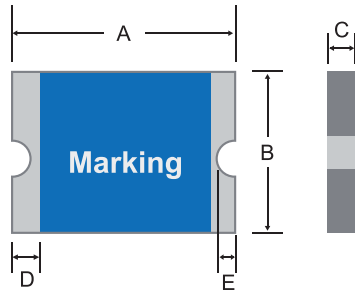

Recommended Pad layout

Model	A		B		C		D		E
	Min.	Max.	Min.	Max.	Min.	Max.	Min.	Max.	Min.
ASMD0603SL035	1.45	1.85	0.65	1.05	0.30	0.70	0.15	0.50	0.1
ASMD0603SL035-12V	1.45	1.85	0.65	1.05	0.30	0.70	0.15	0.50	0.1
ASMD0603SL050	1.45	1.85	0.65	1.05	0.30	0.70	0.15	0.50	0.1
ASMD0603SL050-12V	1.45	1.85	0.65	1.05	0.30	0.70	0.15	0.50	0.1
ASMD0603SL075	1.45	1.85	0.65	1.05	0.30	0.70	0.15	0.50	0.1
ASMD0603SL075-12V	1.45	1.85	0.65	1.05	0.30	0.70	0.15	0.50	0.1
ASMD0603SL100	1.45	1.85	0.65	1.05	0.40	1.00	0.15	0.50	0.1
ASMD0603SL100-12V	1.45	1.85	0.65	1.05	0.40	1.00	0.15	0.50	0.1
ASMD0603SL125	1.45	1.85	0.65	1.05	0.40	1.00	0.15	0.50	0.1
ASMD0603SL125-12V	1.45	1.85	0.65	1.05	0.40	1.00	0.15	0.50	0.1
ASMD0603SL150	1.45	1.85	0.65	1.05	0.50	1.20	0.15	0.50	0.1
ASMD0603SL150-12V	1.45	1.85	0.65	1.05	0.50	1.20	0.15	0.50	0.1
ASMD0603SL175	1.45	1.85	0.65	1.05	0.50	1.20	0.15	0.50	0.1
ASMD0603SL175-12V	1.45	1.85	0.65	1.05	0.50	1.20	0.15	0.50	0.1
ASMD0603SL200	1.45	1.85	0.65	1.05	0.70	1.40	0.15	0.50	0.1
ASMD0603SL200-12V	1.45	1.85	0.65	1.05	0.70	1.40	0.15	0.50	0.1
ASMD0603SL250	1.45	1.85	0.65	1.05	0.70	1.40	0.15	0.50	0.1
ASMD0603SL250-12V	1.45	1.85	0.65	1.05	0.70	1.40	0.15	0.50	0.1
ASMD0603SL260	1.45	1.85	0.65	1.05	0.70	1.40	0.15	0.50	0.1
ASMD0603SL260-12V	1.45	1.85	0.65	1.05	0.70	1.40	0.15	0.50	0.1
ASMD0603SL300	1.45	1.85	0.65	1.05	0.70	1.40	0.15	0.50	0.1
ASMD0603SL300-12V	1.45	1.85	0.65	1.05	0.70	1.40	0.15	0.50	0.1

**Terminal Material:** Tin-Plated Nickel-Copper (Solder Material:Matte Tin (Sn)).

**Lead Solderability:** Meets EIA Specification RS186-9E, ANSI/J-STD-002 Category 3.

## Tape And Reel Specifications (mm)

Governing Specifications	EIA 481-1
W	8.00 ± 0.30
F	3.50 ± 0.10
E1	1.75 ± 0.10
D0	1.55 ± 0.05
D1	0.50 ± 0.10
P0	4.00 ± 0.10
P1	4.00 ± 0.10
P2	2.00 ± 0.05
A0	1.10 ± 0.10
B0	1.85 ± 0.10
T	0.20 ± 0.10
K0	0.72/0.85± 0.10
Leader	390 mm
Trailer	160 mm

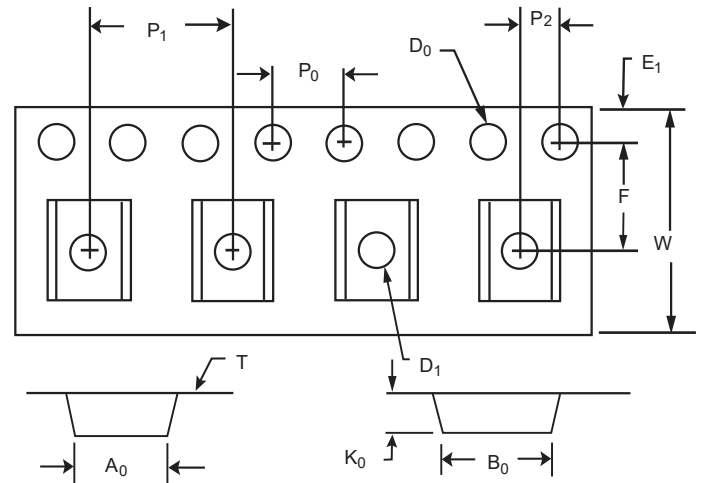

REEL DIMENSIONS: EIA-481-1(mm)	
C	φ 178 ± 1.0
D	φ 60.2 ± 0.5
W	9.0 ± 1.5
H	11.0 ± 0.5

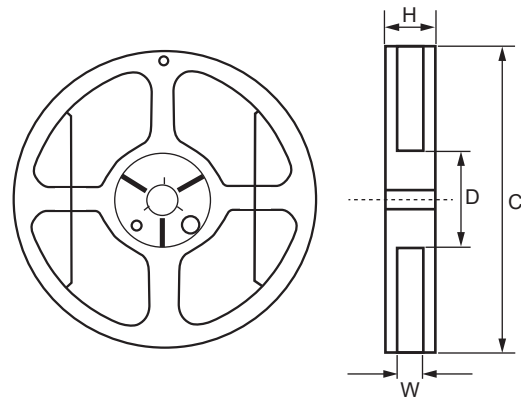

## Packaging Quantity

Model	Quantity
ASMD0603SL035~150	5,000 pcs/reel
The Others	4,000 pcs/reel

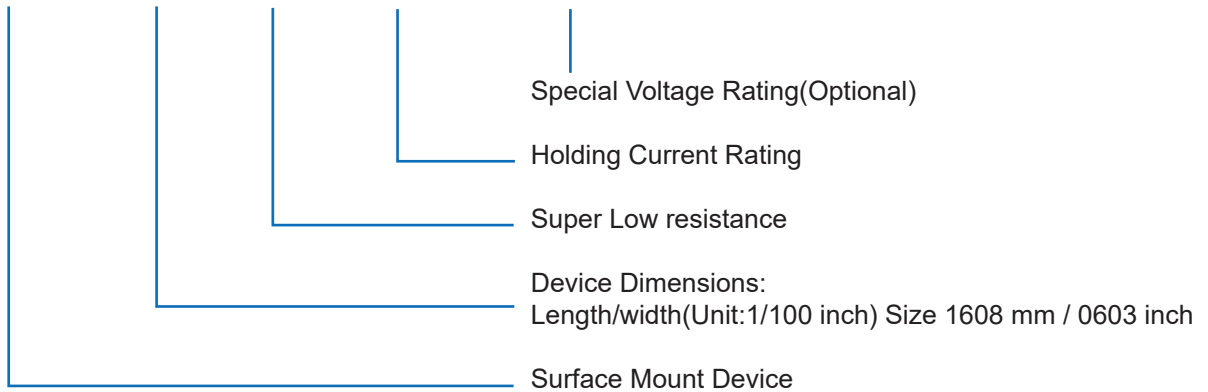

**Part Number System**
**ASMD 0603 SL** □□□ - □□

**Application Notice**

1. Operation of these PPTC devices beyond the stated maximum ratings could result in damage to the devices and lead to electrical arcing and/or fire;

PPTC 器件在超过规定的最大值额定值运行可能会导致器件损坏以及导致电弧和/或火灾。

2. These PPTC devices are intended to protect against the effects of temporary over-current or over-temperature conditions and shall not be taken for use as switch.

PPTC 的作用是防止临时的过流或过温造成的不良影响，不能当作开关使用。

3. Exposure to lubricants, silicon-based oils, solvents, gels, electrolytes, acids, and other related or similar materials may adversely affect the performance of PPTC devices.

PPTC 接触润滑剂、硅基油、溶剂、凝胶、电解质、酸和其他相关或类似材料可能会对 PPTC 器件的性能有不利影响。

4. Circuits with inductance may generate a voltage above the rated voltage of the PPTC device and should be thoroughly evaluated within the user's application during the PPTC selection and qualification process.

带有电感的电路可能产生高于 PPTC 额定电压的电压，因此客户在选型和认定过程中应进行彻底的评估。

5. Please do not smash, clamp, pull, dent or twist by tool during assembling process, as they may result in the PPTC damage.

在装配过程中，避免有砸、挤、拉、扭等方式外力作用于 PPTC 本体上，因为它们可能导致 PPTC 损坏。

6. Hand-soldering of PPTC devices on boards is generally not recommended. Users shall define and verify this process if needed.

不推荐使用手工焊接的方式焊接 PPTC。如果需要，用户需要定义和验证此过程。

7. Recommended storage conditions should be followed at all times, The MSL classification of PPTC is grade 2a. 必须始终遵守推荐的保存条件要求，PPTC 的 MSL 等级为 2 a 级。